

JBL

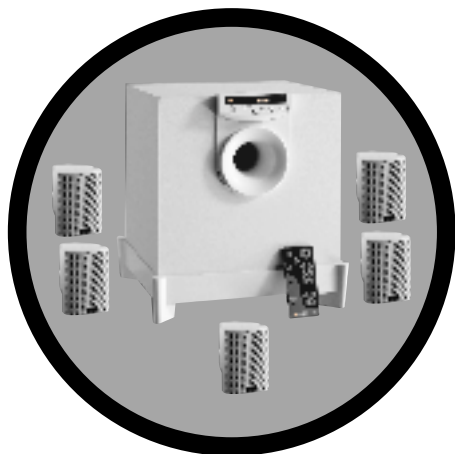

Media 3000

Simple

setup guide

thank you for choosing JBL. For more than 50 years, JBL has been involved in every aspect of music and film recording and reproduction, from live performances to the recordings you play in your home, car or office.

We're confident that the JBL system you have chosen will provide every note of enjoyment that you expected – and that when you think about purchasing additional audio equipment for your home, car or office, you will once again choose JBL.

JBL Consumer Products

Declaration of Conformity



We, Harman Consumer International
2, route de Tours
72500 Château-du-Loir
FRANCE

declare in own responsibility, that the products described
in this owner's manual are in compliance with technical
standards:

EN 55 013/6.1990
EN 55 020/6.1988
EN 55 022/6.1993
EN 60 065/1994
EN 60 555-2-3/1987/88

A handwritten signature in black ink, appearing to read 'Steen Michaelsen', is positioned above the printed name.

Steen Michaelsen
Harman Kardon Europe 11/99

Important Note

Automatic On/Off and Automatic Digital-Input Selection

The Media 3000 offers two unique user-convenience features: Automatic Turn-On/Shut-Down and Automatic Digital-Input Selection.

The Automatic Turn-On feature will turn the Media 3000 on as soon as a source connected to its digital inputs (such as DVD, or any other device featuring a coaxial or optical digital output) is switched on, or as soon as the unit connected to its last-used analog input starts outputting sound.

When using digital inputs, the Automatic Turn-On can be activated by turning on either one of the connected digital sources such as a DVD player or a CD player with digital output. When using analog inputs (TV or AUX), Automatic Turn-On is available only for the device that was last listened to before the Media 3000 shut down. In order to listen to the other device, the Media 3000 input needs to be manually selected by using the Input button on the product and on the remote, which, in turn, disables the Automatic Digital-Input Selector until the Media 3000 is shut down.

The Automatic Turn-Off shuts the unit down five minutes after all sources connected to its digital inputs are powered down and the device connected to its selected analog input stops playing.

The Automatic Digital-Input Selector automatically selects the source connected to its digital inputs when that source is powered on. Upon power down of this digital unit, if no other source is on, the Media 3000 will switch itself off after five minutes.

If the analog source that was selected prior to the digital source turning on is still playing, the Media 3000 will switch back to that other source. Once a digital source is powered on and selected as an input, turning on a device connected to the other digital input will not switch the input until the selected digital device is first powered off.

These two features can only be used if the customer does not manually turn the Media 3000 on or off, and does not manually select an input source. Once either of these selections is made manually, the automatic features are disabled as follows:

1. If the Media 3000 is turned off manually, it will not turn back on automatically until five minutes after the source connected to the Media 3000 is shut down. During these five minutes, it can be turned on either from the front panel or via the remote control.
2. Once an input source is selected manually, the Automatic Source-Selection feature will remain disabled until the Media 3000 shuts down.
3. Once any one of the two devices connected to the Media 3000 digital inputs is powered on and its input is selected by the Media 3000, the device connected to the other digital input of the Media 3000 cannot be automatically selected until the already selected digital device is powered down.

included

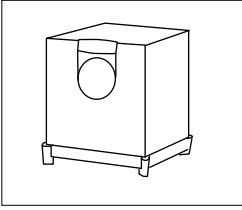

"Smart" powered subwoofer/controller.

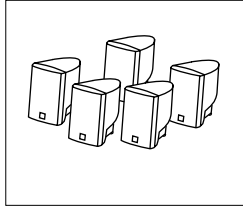

Five satellites for left, right, center and surrounds.

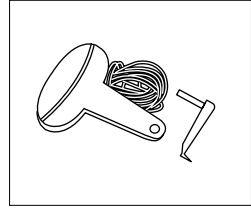

Foot for horizontal placement of center speaker. Versatile remote sensor and double-sided tape provided.

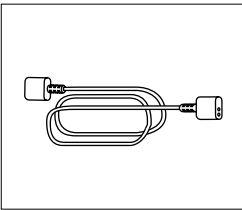

JBL "error free" speaker cables. Extension cable XC300 available in 10-foot lengths in either white or black.

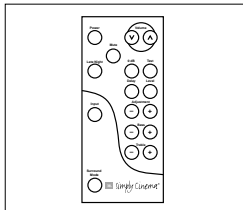

Remote control.

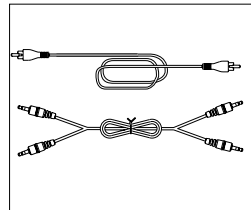

Digital coax input cable and analog RCA input cable.

Features

- Complete, self-powered Dolby* Digital home-cinema sound system with five satellite speakers, subwoofer, remote control, and all amplification built in.
- Dolby Digital (AC-3* 5.1 channel), Dolby Pro Logic*, including Phantom and 3-Stereo, and Stereo listening modes.
- Automatic Turn-On and Turn-Off.
- Automatic Source Switching for the digital inputs.
- Two digital (one optical and one coaxial) inputs and two analog inputs.
- 2-Way video-shielded micro-satellites with titanium-laminate tweeters and common voicing for all five channels, and an 8-inch, long-throw, floor-firing subwoofer.
- Late Night compression for nighttime listening without unexpected and objectionably loud passages.
- All amplification and controls are mounted in the subwoofer, eliminating the need for a separate control unit.
- Remote controllable via outboard remote eye that can be mounted with the center channel or separately, so that the subwoofer can be hidden away.

- Wall-mount brackets and floor stands available separately for the satellites.
- Credit-card-type, full-function remote control.
- JBL “error free” speaker cables simplify connection and eliminate possibility of out-of-phase wiring.
- Center foot for horizontal placement of the center channel.
- Rotatable JBL logos to allow for vertical or horizontal placement of the satellites.

About Dolby Digital

The Media 3000 features Dolby Digital (also unofficially known as AC-3) multichannel signal processing, a system developed by Dolby Laboratories.

Dolby Digital, unlike “matrixed” systems (such as Dolby Pro Logic) that derive and decode multichannel sound from two channels of sound, is capable of delivering information for one subwoofer and five full-range channels as discrete and individual channels in digital AC-3 data format from sources

such as a DVD player. The result is clear and accurate digital sound to each speaker, along with availability of stereo-surround effects (Dolby Pro Logic features mono surrounds).

Dolby Digital is capable of delivering several different formats of surround sound, the most robust one being the 5.1-channel mode, which provides separate signals for five satellite speakers as well as for a subwoofer. The Media 3000 features a “5.1-Ch” indicator

that illuminates when a Dolby Digital 5.1-channel encoded signal is present. Dolby Digital can also provide other AC-3 digital multichannel signals, as well as 2-channel signals, which can be decoded via Dolby Pro Logic processing into multichannel surround sound. In the latter case, both the Dolby Pro Logic and Dolby Digital indicators will illuminate in the Media 3000 display.

one. Speaker Placement

Satellites

Subwoofer

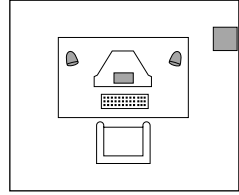
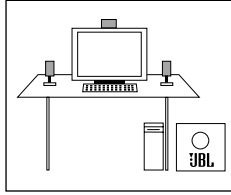
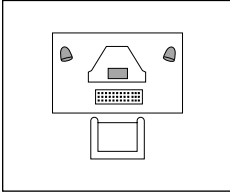

Mounting Remote Sensor to Center Speaker.

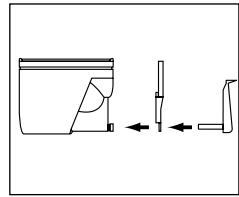
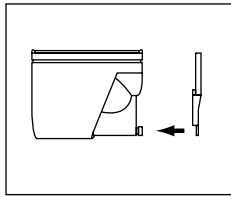
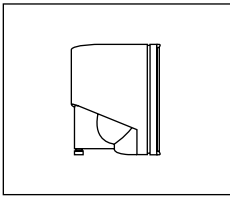

Center speaker.

Place remote sensor at bottom of center speaker.

Insert support leg through remote sensor and into speaker.

The remote sensor may be placed anywhere using the supplied double-sided tape.

Surround Speakers

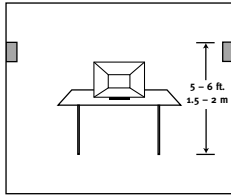
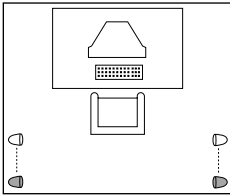

Mounting Options

Satellites and Surrounds

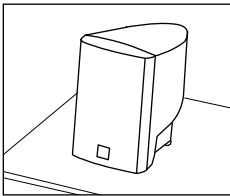

On shelves.

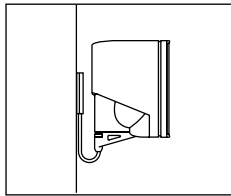

On the wall. Optional bracket, WB300 or WB300WHT (white).

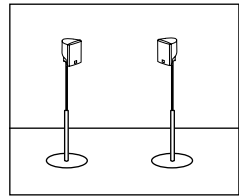

On optional stands, FS300 or FS300WHT (white).

two. Speaker, Source, and Remote-Sensor Connectors

(rear panel of subwoofer)

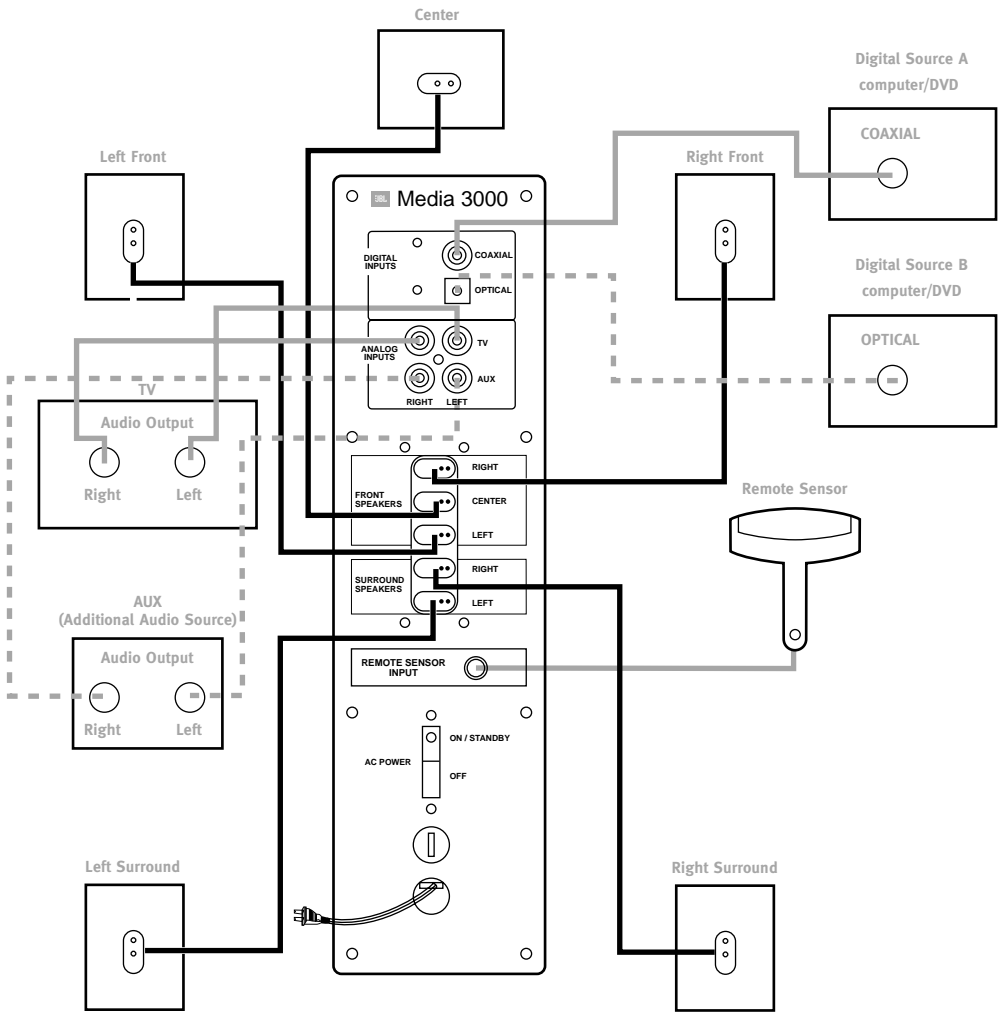

Speaker and Amplifier Connection

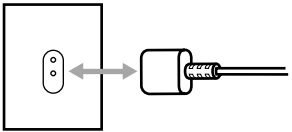

Dashed lines indicate that wire is not included

Extension cables, XC300, available in 10-foot lengths from your JBL dealer.

three. Operation

Remote-Control-Battery Installation.

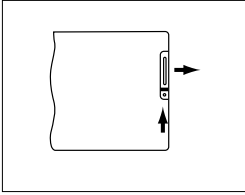

Push small tab towards battery slot and pull battery drawer out.

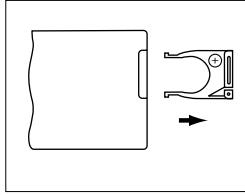

Remove old battery.

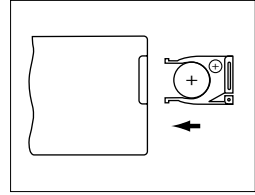

Insert new battery with “+” side up, and slide battery drawer back into remote.

Rear-Panel Control

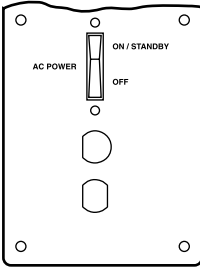

Master On/Off Switch

To operate unit, place this switch in the On/Standby position. The system will go into standby when no signal has been received and when no unit connected to any of its two digital inputs has been on for approximately five minutes.

Remote and Front-Panel Controls and Indicators

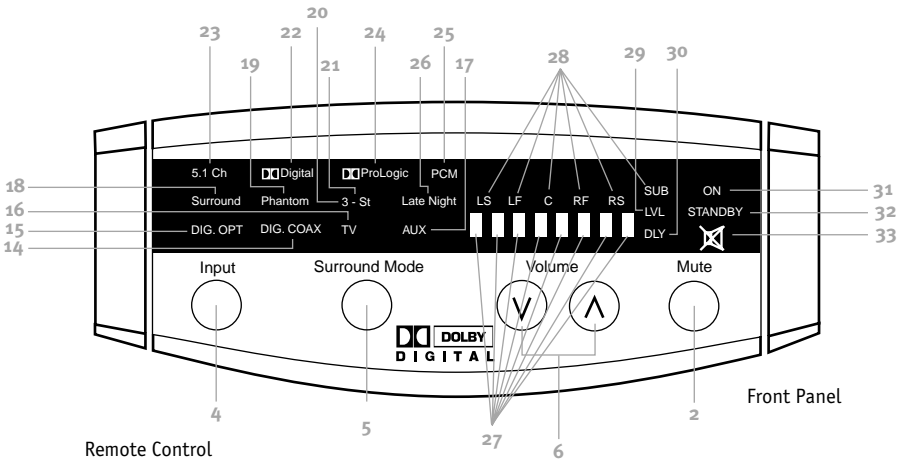

1. Power

This button, located only on the remote control, allows the user to manually turn on or off the Media 3000. Please note that the Media 3000 features Automatic Turn-On/Off, and the power switch is not normally used unless it is necessary to override this automatic feature, or in case the analog input to be used is not the last one that was used and so Automatic Turn-On is not available for that input. Please read the details regarding Automatic Turn-On/Off on page 3

of this manual, and keep in mind that if the Media 3000 is shut down using this power button, its automatic turn on feature will remain disabled for five minutes after the source connected to the Media 3000 is shut down also. This is to prevent the Media 3000 from repeatedly turning itself back on despite the user's wishes. The Media 3000 can also be powered on by using the Input button (4) on the front panel of the subwoofer or on the remote control. Please note that if input selection is done by pressing the Input button, the Automatic Digital Input Selection of the Media 3000 will be disabled until the Media 3000 shuts down.

When the Media 3000 is plugged into a working electrical outlet and its master switch on the back panel is set to On/Standby, the Standby (32) indicator will illuminate. The ON (31) indicator will light as soon as the Media 3000 is turned on either automatically or via the pressing of the Power or Input buttons.

2. Mute

From either the front panel or the remote control, press (Mute) to lower the volume completely. The mute symbol indicator (33) will illuminate. When you press either of the mute buttons again, the volume will return to its previous setting. Note: The mute function can also be turned off by pressing either of the volume buttons on the front panel or the remote control.

3. Late Night

This feature is available for Dolby Digital only. It compresses the inherently dynamic digital sound so that the quiet and loud passages are not quite as different in sound levels as they ordinarily are. This feature allows the user to watch movies and listen to dialogue at toned-down levels so as not to disturb others with the loud sound effects that may be present. The Late Night indicator (26) illuminates when this feature is active.

4. Input

This control is available on both the front panel and the remote control. It allows manual selection when the user repeatedly presses and releases the button for any of the Media 3000's four inputs. The Media 3000 features an Automatic Digital Input Selection feature that automatically switches the Media 3000 to the source connected to one of its two digital inputs as soon as that device is powered on. Please read the section on page 3 to thoroughly familiarize yourself with the conveniences and conditions of using the Automatic Digital Input Selection feature. The Input switch is also used when the source connected to the Media 3000's analog input is not the analog source that was listened to the last time the Media 3000 was on (and hence the Automatic Turn-On feature is not available). The Input switch also turns on the Media 3000 when pressed (see item 1 earlier in this section). Whenever a specific input is selected either manually or automatically, its indicator (14, 15, 16 or 17) on the Media 3000's front panel will be illuminated.

5. Surround Mode

Pressing and releasing this button allows the selection of different listening modes. Surround (18), Phantom (19) and 3-Stereo (20) are available listening options for Dolby Digital and Dolby Pro Logic. Stereo (21) bypasses the surround processing and outputs sound through the right- and left-front speakers only. In Surround mode, all five satellites and the subwoofer will play. In Phantom mode, all speakers except the center

channel will play. In 3-Stereo, all speakers except for the two surround speakers will be active.

6. Volume

Press (∧) on the remote control or the front panel to raise the system's volume. Press (∨) on the remote control or the front panel to lower the system's volume. The volume setting is indicated on the status-bar indicator (27).

7. 0 dB

Press this button to reset the Center, Surround, Balance, Treble and Bass controls to their default positions.

8. Test

Press this button to activate the Test Tone mode (see Test Tone section).

9. Delay

The relative timing of sounds coming from the center and/or surround speakers compared to the front-left and front-right speakers can be adjusted. The first press of this button allows adjustment of the center channel, all the way from the default setting of 0 ms (milliseconds), which means no delay (all status bars off), to a maximum of 5 ms (5 status bars on). The indicators C (28) and DLY (30) will be on. The second press of the Delay button allows adjustments of the surround speakers; indicators LS (28) and RS (28) and DLY (30) will be on. The delay can be adjusted from zero (all status bars off) to 15 ms (all status bars on) in 5.1 Channel Dolby Digital and from 15 ms (all status bars off) to 30 ms (all status bars on) in Dolby Pro Logic (there is an inherent and fixed 15 ms of delay added in the "matrixed" Dolby Pro Logic to re-create the

proper surround effect). The center and surround delay adjustments can be done from either Dolby Digital or Dolby Pro Logic "matrixed" modes. There are no separate delay adjustments for the individual modes of operation. During adjustments, the audio mutes momentarily every time the Adjustment +/- button (11) is pressed. Please note that the status-bar indicator (27) will not display unless Adjustment +/- buttons are pressed. Also, while the status-bar indicator (27) is on, channel indicators (28) and DLY (30) will not be displayed. And, if adjustments are done in a mode where a certain channel is not available, the adjustment step for that channel is skipped. For example, in Phantom mode, the center-channel delay cannot be adjusted since Phantom does not have a center channel. In Stereo, neither the center nor the surround delay can be adjusted since Stereo does not feature surround speakers or a center speaker. A third press of the Delay button will exit the Media 3000 from its delay-adjustment mode.

10. Level

The relative level of sounds coming from each of the Media 3000's speakers can be adjusted while listening to program material on the Media 3000. Repeated pressing and releasing of the Level button allows access to each channel. The display will indicate LVL (29), and the channel indicators (28) LF (Left Front), C (Center), RF (Right Front), LS (Left Surround), RS (Right Surround) and SUB (subwoofer) will illuminate to indicate the active speaker. The level for the selected channel can then be changed using the Adjustment +/- buttons (11).

Levels set in one mode will stay valid for all other modes and are not independent. Please note that the status-bar indicator (27) will not display unless Adjustment +/- buttons are pressed. And, while the status-bar indicator (27) is on, channel indicators (28) and LVL (29) will not be displayed. Also, if adjustments are done in a mode where a certain channel is not available, the adjustment step for that channel is skipped. For example, in Phantom mode the center-channel level cannot be adjusted since Phantom does not have a center channel. In stereo, neither the center nor the surround levels can be adjusted since Stereo does not feature surround speakers or a center speaker. A seventh press of the Level button will exit the Media 3000 from its level-adjustment mode.

11. Adjustment

These buttons are used in conjunction with Test (8), Delay (9), and Level (10) to increase or decrease a setting.

12. Bass

Press (+) to increase the level of low-frequency information.
Press (-) to decrease the level of low-frequency information.

13. Treble

Press (+) to increase the level of high-frequency information.
Press (-) to decrease the level of high-frequency information.

14–17. Input

One of these four indicators will illuminate, depending on which input is selected.

18–21. Surround

One of these will illuminate, depending on which surround mode is chosen.

22. Dolby Digital

Indicates the presence of a Dolby Digital-encoded AC-3 digital signal.

23. 5.1-Ch

Works in conjunction with the Dolby Digital indicator (22). This indicator illuminates when the Dolby Digital signal contains 6 discrete channels of information (one subwoofer and five satellite channels).

24. Dolby Pro Logic

Illuminates when Dolby Pro Logic decoding of a 2-channel signal is taking place. This indicator may be on by itself (when analog inputs are used), in conjunction with Dolby Digital (when using a digital input where the AC-3 format signal contains two channels and needs to be decoded into multichannel) or together with PCM (when using a digital input where 2-channel PCM-format data is being decoded into multichannel).

25. PCM

Illuminates when the signal supplied through the selected digital input is in PCM format.

26. Late Night

Illuminates when the Late Night compression is selected.

27. Status-Bar Indicator

These LEDs show the relative setting of volume, bass, treble, speaker level and speaker delay.

28. Speaker Indicator

Identifies the speaker that's being adjusted. LS is Left Surround, LF is Left Front, C is Center, RF is Right Front, RS is Right Surround, and SUB is Subwoofer.

29. Level

Illuminates when the Media 3000 is in speaker-level adjustment mode.

30. Delay

Illuminates when the Media 3000 is in speaker-delay adjustment mode.

31. On

Indicates that the Media 3000 is fully powered up.

32. Standby

Indicates that the Media 3000 is plugged into an active wall outlet and the master switch on the back panel is in On/Standby position, but the unit is not powered on.

33. Mute

Illuminates when the mute function is activated (the Media 3000 will be on but will not produce any sound).

Status-Bar Indicators

LED Bar Indicators illuminate in response to adjustments in volume, delay, level, bass and treble controls.

Volume, Level, Delay

Increase

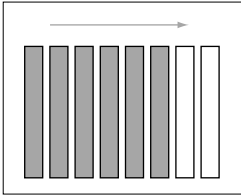

Decrease

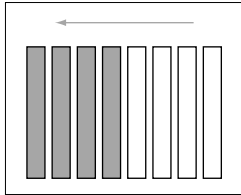

Bass, Treble

Increase

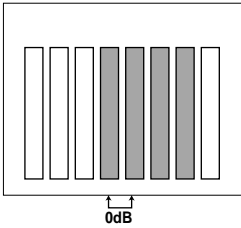

Decrease

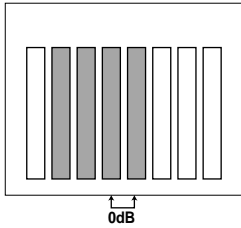

Surround Modes

Surround

Use this mode for movie or music recorded using Dolby Digital or Dolby Pro Logic Surround.

Phantom

This mode creates surround sound from stereo recordings. The center channel is not used and the surround channels have a 20-ms delay.

3-Stereo Mode

Use this mode to play back Pro Logic-encoded films when you do not want the surround channels to play.

Stereo

This mode plays a recording in traditional two-channel stereo.

Test Tone

The Test Tone is used to calibrate the volume settings of each of the speakers in the Media 3000. It is dependent on the room where the system is set up and the relative distances and positions of each speaker to the listening position. In Dolby Digital mode, a static-like noise will be heard cycling, in order: left front, center, right front, right surround, left surround, subwoofer. In modes other than Dolby Digital, the sound from the two surrounds will be coming at the same time, since the surrounds in all available modes, except in Dolby Digital, are in mono. When the Test Tone is heard coming from a specific channel, pressing the Adjustment +/- (11) buttons will increase or decrease the level of sound coming from that channel. The display status-bar indicator (27) provides visual indication of the adjustment as the adjustment is being made.

The default adjustment level of 0 dB is indicated by five status-bar indicators illuminated.

If adjustments are done in a mode where a certain channel is not available, the adjustment step for that channel is skipped. For example, in Phantom mode, the center-channel level cannot be adjusted since Phantom does not have a center channel. In stereo, neither the center nor the surround levels can be adjusted since Stereo does not feature surround speakers or a center speaker.

Using the remote control, adjust each channel's levels until the volume of all the speakers is the same during the test. To make sure all channels are properly adjusted, do the test twice, once in Dolby Digital (Dolby Digital is automatically selected when the Media 3000 is connected to a DVD player's digital output, that specific

digital input is selected, and the DVD player is playing Dolby Digital-encoded material) and once again in Dolby Pro Logic.

Note: The Test Tone is used to calibrate the system to reproduce all program materials at the correct relative levels, as was determined by the recording engineers. When listening to actual surround-encoded program material, the volume level of the surround channels is generally lower than that of the front channels. In fact, virtually all of the dialogue and a substantial number of the effects in a movie are reproduced through the center channel.

Troubleshooting

If there is no sound from any of the speakers:

- Make sure the subwoofer is plugged into an active AC wall outlet.
- Make sure the Master Power Switch, located on the rear of the subwoofer, is in the On/Standby position.
- Make sure there is a source – for example, a DVD Player, or DVD equipped computer – hooked up to one of the four input jacks.
- Make sure that the program material is playing.
- Recheck the hookup connections, referring to the Speaker Connections section.

If there is no sound from the surround speakers or sound is very low:

- Check all connections between processor/amplifier and each of the speakers.
- Raise the surround volume from the remote control (see Operation section).
- Make sure the movie you are watching or the software you are using are recorded in Dolby Digital or Pro Logic Surround. If it is not, try the Phantom or Simulated Surround mode.
- Increase the surround-speakers' level, using the level-adjustment instructions found earlier in this manual.

If there is no sound from the center speaker:

- Make sure that the processor is in the Surround or 3-Stereo mode. If it is in Phantom or Stereo mode, the center speaker will not play.
- Increase the level of the center channel, using the level-adjustment instructions earlier in this manual.
- Check the connections between the subwoofer and the center speaker.

If you have low bass output:

- Experiment with placement of the subwoofer. Remember, place the subwoofer in a corner to get maximum bass output from the system.
- Increase the subwoofer level, using the level-adjustment instructions found earlier in this manual.
- Increase the level of bass, using the remote control.

Specifications

Media 3000 System

Power Output

Satellites:

35 Watts x 5 @ 0.1% THD

Subwoofer:

65 Watts x 1 @ 0.1% THD

Signal-to-Noise Ratio

90 dBA

Input Impedance

(analog inputs)

20k ohms

Input Sensitivity

(analog inputs)

400mV

Auto Turn-On Sensitivity

(analog inputs)

2mV

Frequency Response (-6 dB)

35Hz – 20kHz

Dimensions (H x W x D)

Satellites (each):

4-3/8 x 3-3/16 x 3-3/4 inches

111 x 81 x 95mm

Subwoofer:

15-1/8 x 13 x 14-1/2 inches

384 x 330 x 368mm

Occasional refinements may be made to existing products without notice, but will always meet or exceed original specifications unless otherwise stated.



CAUTION
RISK OF ELECTRIC SHOCK
DO NOT OPEN



CAUTION: TO REDUCE THE RISK OF ELECTRIC SHOCK, DO NOT REMOVE COVER (OR BACK). NO USER-SERVICEABLE PARTS INSIDE. REFER SERVICING TO QUALIFIED SERVICE PERSONNEL.



The lightning flash with arrowhead symbol, within an equilateral triangle, is intended to alert the user to the presence of uninsulated "dangerous voltage" within the product's enclosure that may be of sufficient magnitude to constitute a risk of electric shock to persons.



The exclamation point within an equilateral triangle is intended to alert the user to the presence of important operating and maintenance (servicing) instructions in the literature accompanying the appliance.

WARNING: TO REDUCE THE RISK OF FIRE OR ELECTRIC SHOCK, DO NOT EXPOSE THIS APPLIANCE TO RAIN OR MOISTURE.

Handle the Power Cord Gently

- To disconnect the plug from the AC outlet, pull on the plug itself, not on the cord. Pulling the cord may break the wire.
- Disconnect the plug from the AC outlet whenever the unit is to be left unused for an extended period of time.
- Do not place furniture or other heavy objects on the cord, and avoid dropping heavy objects on it. Also, do not make a knot in the cord; this can damage it and cause a fire hazard.

JBL Consumer Products

250 Crossways Park Drive, Woodbury, NY 11797

8500 Balboa Boulevard, Northridge, CA 91329

1-800-336-4JBL (4525) (USA only)

Harman Consumer International: 2, route de Tours, 72500 Château-du-Loir, FRANCE

www.jbl.com

© 1999 JBL, Incorporated.

JBL are registered trademarks of JBL, Incorporated.

*Trademarks of Dolby Laboratories.

♻ Part No. Media 30000M

A Harman International Company